

Dual setting type, High accuracy temperature controller

■ Features

- Dual setting type
- High accuracy measuring function : $\pm 0.5\%$
- Control heater and cooler at once
- Use dual setting type of temperature when executing low temperature or precision control. In dual setting control type, the single output is operated as reverse, it is used for heater control. The dual output is used to control the operation of cooler normally. The dual output is also used for an alarm.



⚠ Please read "Caution for your safety" in operation manual before using.

■ Ordering information

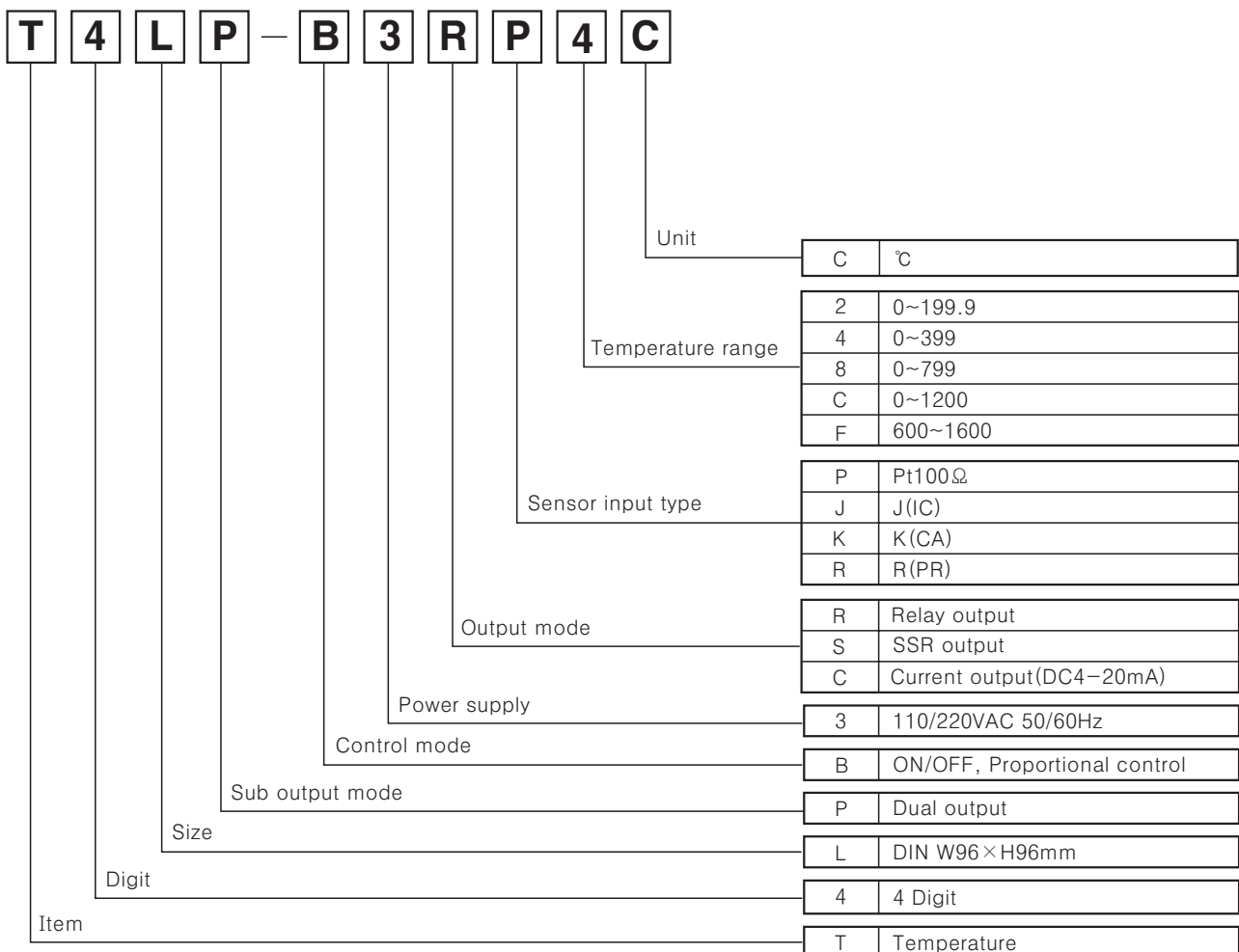

※ See C-34 about sensor temperature range for selection.

Dual Setting Type

Temperature range for each sensor

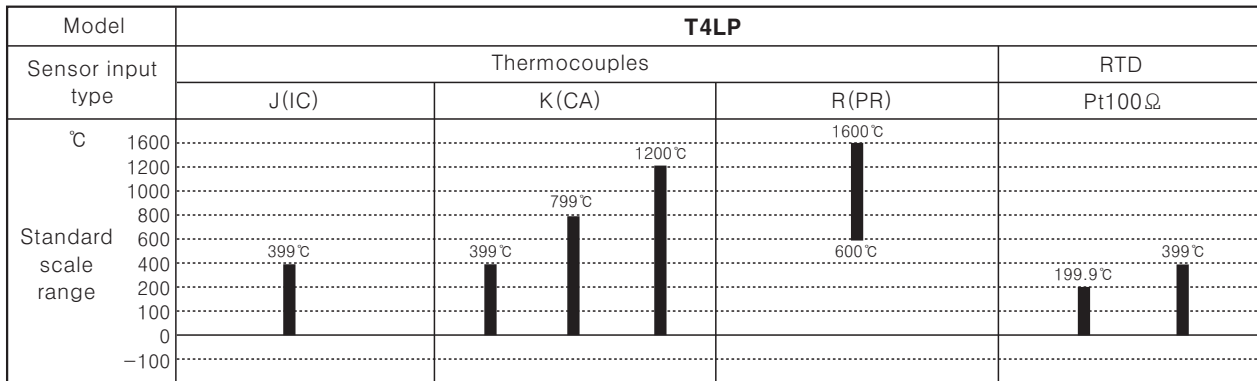

※ In case, the sensor is R(PR) type, it is not available to indicate the temperature and control correctly.

Specifications

Model	T4LP	
Power supply	110/220VAC 50/60Hz	
Allowable voltage range	90 ~ 110% of rated voltage	
Power consumption	3VA	
Display method	7 Segment LED Display	
Character size	W9.5×H14.2mm	
Display accuracy	F · S ± 0.5% rdg ± 1digit	
Setting type	Digital switch setting	
Setting accuracy	F · S ± 0.5%	
Sensor input	Thermocouples : K(CA), J(IC), R(PR) / RTD : Pt100Ω	
Input line resistance	Thermocouples : Max. 100Ω, RTD : Max. 5Ω per a wire	
Control	ON/OFF	Hysteresis F · S 0.2 ~ 3%
	Proportional	Proportional band : F · S 1 ~ 10%, Period : 20sec. fixed
RESET adjuster range	F · S ± 3% (Only for control deviation)	
Control output	<ul style="list-style-type: none"> Relay output : 1st out : 250VAC 3A 1c, 2nd out : 250VAC 2A 1c SSR output : 24VDC ± 3V 20mA max. Current output : DC4~20mA Load 600Ω max. 	
Self-diagnosis	Includes burn out function	
Insulation resistance	Min. 100MΩ (at 500VDC mega)	
Dielectric strength	2000VAC 50/60Hz for 1 minute	
Noise strength	± 2kV the square wave noise (pulse width: 1μs) by the noise simulator	
Vibration	Mechanical	0.75mm amplitude at frequency of 10 ~ 55Hz in each of X, Y, Z directions for 1 hour
	Malfunction	0.5mm amplitude at frequency of 10 ~ 55Hz in each of X, Y, Z directions for 10 minutes
Shock	Mechanical	300m/s ² (Approx. 30G) 3 times at X, Y, Z direction
	Malfunction	100m/s ² (Approx. 10G) 3 times at X, Y, Z direction
Relay life cycle	Mechanical	Min. 10,000,000 times
	Electrical	Min. 100,000 times (250VAC 3A at resistive load)
Ambient temperature	-10 ~ +50°C (at non-freezing status)	
Storage temperature	-20 ~ +60°C (at non-freezing status)	
Ambient humidity	35 ~ 85%RH	
Unit weight	Approx. 487g	

※ (Note) F.S is same with sensor measuring temperature range.

Ex) In case of using temperature is from -99.9 ~ 199.9°C, Full scale is 299.8.

(A) Counter

(B) Timer

(C) Temp. controller

(D) Power controller

(E) Panel meter

(F) Tacho/Speed/Pulse meter

(G) Display unit

(H) Sensor controller

(I) Switching power supply

(J) Proximity sensor

(K) Photo electric sensor

(L) Pressure sensor

(M) Rotary encoder

(N) Stepping motor & Driver & Controller

(O) Graphic panel

(P) Production stoppage models & replacement

T4LP

Connections

※RTD(Resistance Temperature Detector) : Pt 100Ω(3-wire type)

※Thermocouple : K, J, R

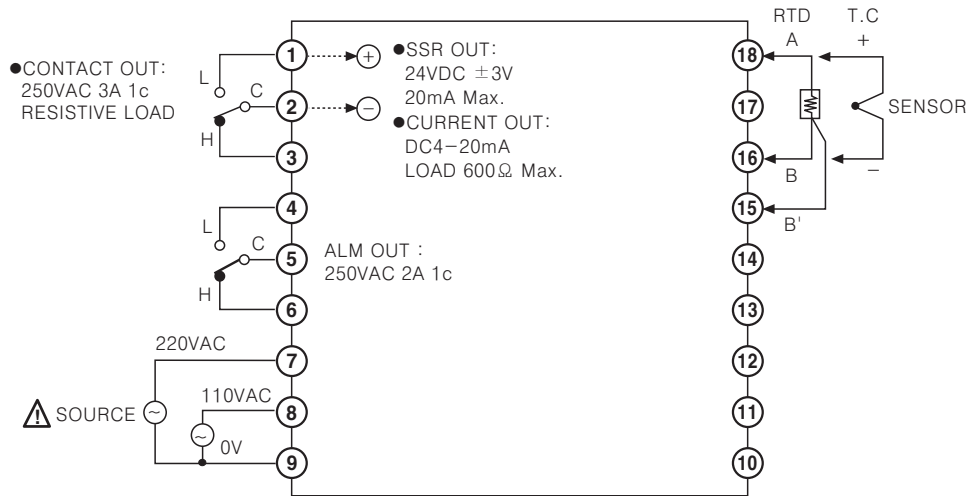

Dimensions

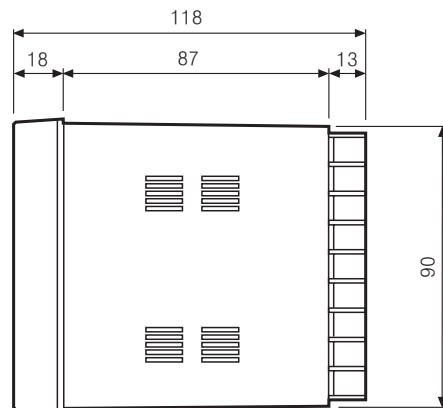
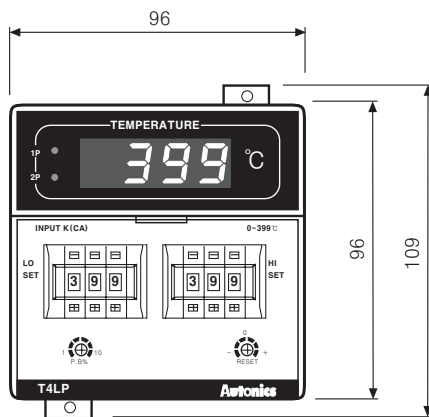

●Panel cut-out

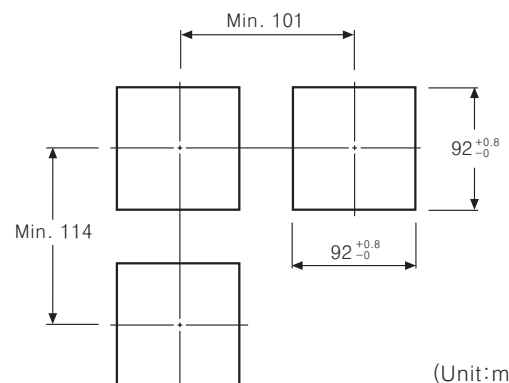

(Unit:mm)

Dual Setting Type

■ Proper usage

◎ Operation

This controller has two outputs operated separately. In other words, it is able to set the values separately. Front Low Set runs with reverse operation as other common controllers and High Set runs by normal operation. It is able to control heater and cooler.



※ Terminal block ①, ②, ③ are for Low set output and terminal block ④, ⑤, ⑥ are for High set output.

◎ Using front adjuster

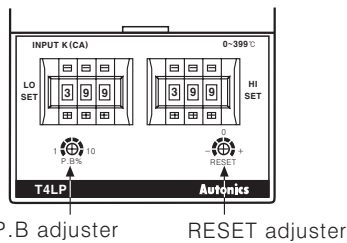

● P.B. adjuster

In case of ON/OFF control, set variable $F \cdot S$ 0.2~3% of hysteresis, and in case of proportional control, set variable $F \cdot S$ 1~10% of hysteresis.

● RESET adjuster

It corrects offset can be occurred by proportional control and has $F \cdot S \pm 3\%$ of adjustable range.

Do not operate the adjuster when it is used as ON/OFF control.

① Turn left when offset value is higher than set value. (Direction ①)

② Turn right when offset value is lower than set value. (Direction ②)

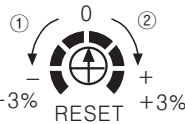

◎ Case detachment

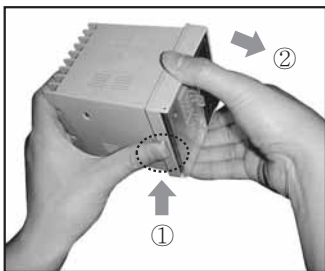

Pressing the front guide of Lock toward ① and squeeze and pull toward ②, it is detached.

◎ How to select ON/OFF or proportional by plug pin

Factory specification is proportional control. When using ON/OFF control, transfer the switch of control mode from P to F after detaching the case from its body.

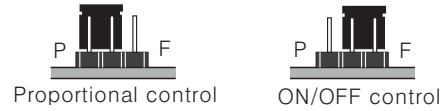

◎ Normal/Reverse operation

Reverse operation executes to output ON when process value is lower than setting value, and it is used for heating.

Normal operation is executed conversely and used for cooling. (This item runs as a reverse operation.)

◎ Application of temperature controller and load connection

● SSR output

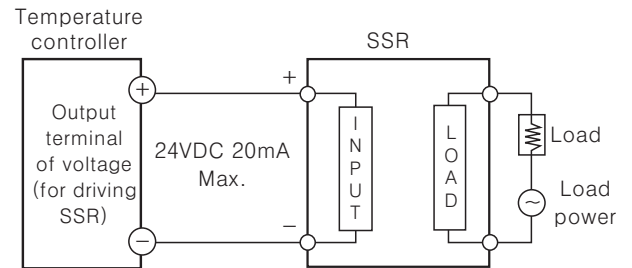

※ When using voltage (for driving SSR) in the other purposes, do not exceed the range of the rated current.

● Relay output

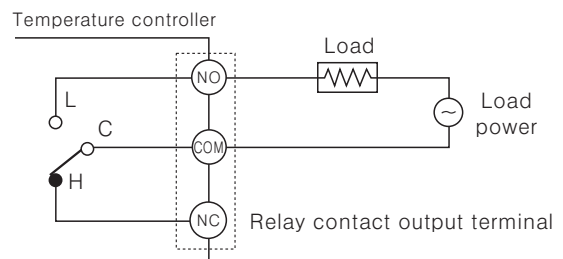

Output	Relay contact capacity
1st OUT	250VAC 2A
2nd OUT	250VAC 3A

● Current output

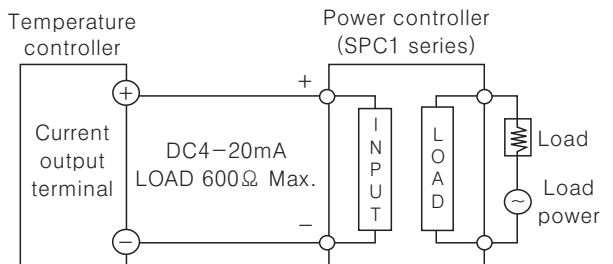

※ The current value of DC4-20mA is available at lower than 600Ω of resistive load.

- (A) Counter
- (B) Timer
- (C) Temp. controller
- (D) Power controller
- (E) Panel meter
- (F) Tacho/Speed/Pulse meter
- (G) Display unit
- (H) Sensor controller
- (I) Switching power supply
- (J) Proximity sensor
- (K) Photo electric sensor
- (L) Pressure sensor
- (M) Rotary encoder
- (N) Stepping motor & Driver & Controller
- (O) Graphic panel
- (P) Production stoppage models & replacement